



www.amtex.com.au

6000 Series Operation Manual

2A Angas St, Meadowbank NSW 2114

Tel: (02) 9809 5022

Fax: (02) 9809 5077

6000 Series

Copyright

Copyright © 1995 by this company. All rights reserved. No part of this publication may be reproduced in any form or by any means without the written permission of this company.

Disclaimer

This company makes no representations or warranties, either expressed or implied, with respect to the contents hereof and specifically disclaims any warranties, merchantability or fitness for any particular purpose. Further, this company reserves the right to revise this publication and to make changes from time to time in the contents hereof without obligation of this company to notify any person of such revision or changes.

6000 Series

Table of Contents

1. Overview	1
1.1 Introduction	1
1.2 Unpacking and Checking	1
2. Front and Rear Panels	2
2.1 Front Panel	2
2.2 Rear Panel	5
3. Operation	6
3.1 Pre-installation	6
3.2 Setting the Output Voltage and Output Current	6
3.3 Constant Voltage/Constant Current Characteristics ..	7
3.4 Operation Modes	7
3.4.1	Independent Mode 7
3.4.2 Serial Tracking Mode	8
3.4.3 Parallel Tracking Mode	9
3.5 Fixed 5V/5A Output	10
3.6 Serial Operation	11
3.7 Parallel Operation	12
4. Maintenance	13
4.1 Changing the Fuse	13
4.2 Changing the Voltage	13
5. Specifications	14

6000 Series

1. Overview

This 6000 Series Direct Current (DC) Power Supply Operation Manual contains an introduction to the power supply, a description of its functions, the operation procedure, the scope of applications and its specifications. The models available under this series are the 6302A, 6302AR, 6302D, 6302DR, 6303A, 6303AR, 6303D, 6303DR, 6306A, 6306AR, 6306D, 6306DR, 6603A, 6603AR, 6603D, and 6603DR.

1.1 Introduction

The 6000 Series is a dual-channel-output DC power supply with the following features:

- Twin power output with tracking function for automatic selection of parallel or serial connection
- Short-circuit protection against external input while providing constant voltage and constant current
- Allows serial or parallel connection with the same power supply model
- 5V/5A constant-voltage output

Special Functions on Remote Models

The following functions are available only on the remote models 6302AR, 6302DR, 6303AR, 6303DR, 6306AR, 6306DR, 6603AR and 6603DR:

- Control of output voltage and current using external voltage and resistor
- Output voltage readback
- Output current readback
- Random master or slave combination

1.2 Unpacking and Checking

Unpack and check that you have the following items:

- One power cable
- This Operation Manual
- Remote-Control Operation Manual (remote models only)
- Two ACS-002 banana clips
- Two 9-pin RS-232C connectors (remote models only)

6000 Series

2. Front and Rear Panels

2.1 Front Panels

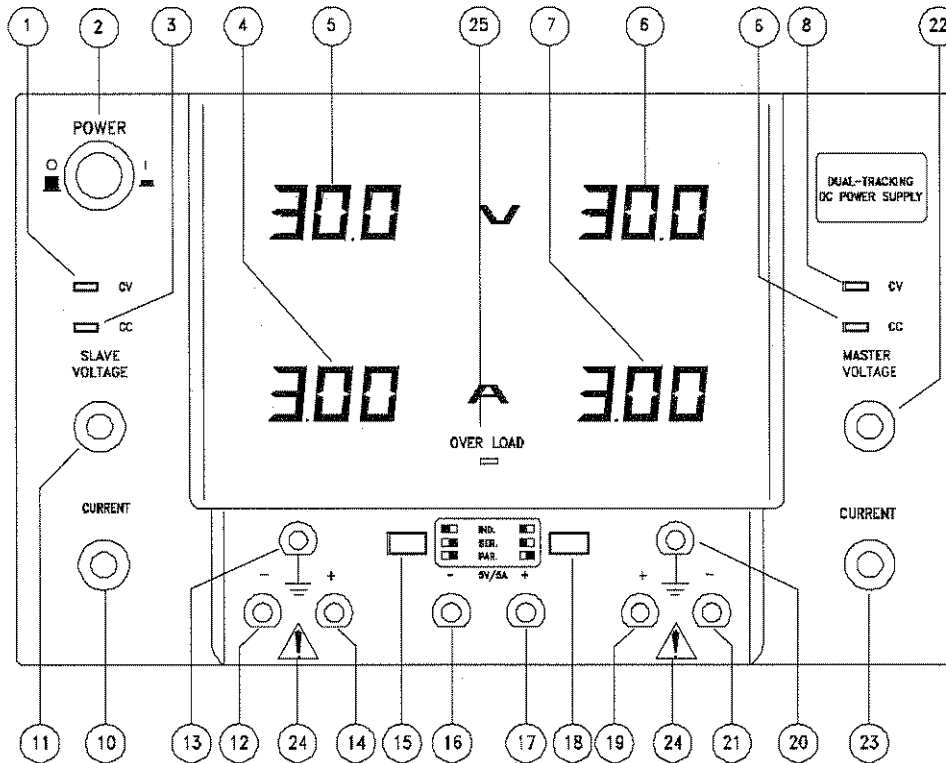

Front panel with digital display for models 6302D, 6302DR, 6303D, 6303DR, 6306D, 6306DR, 6603D and 6603DR

6000 Series

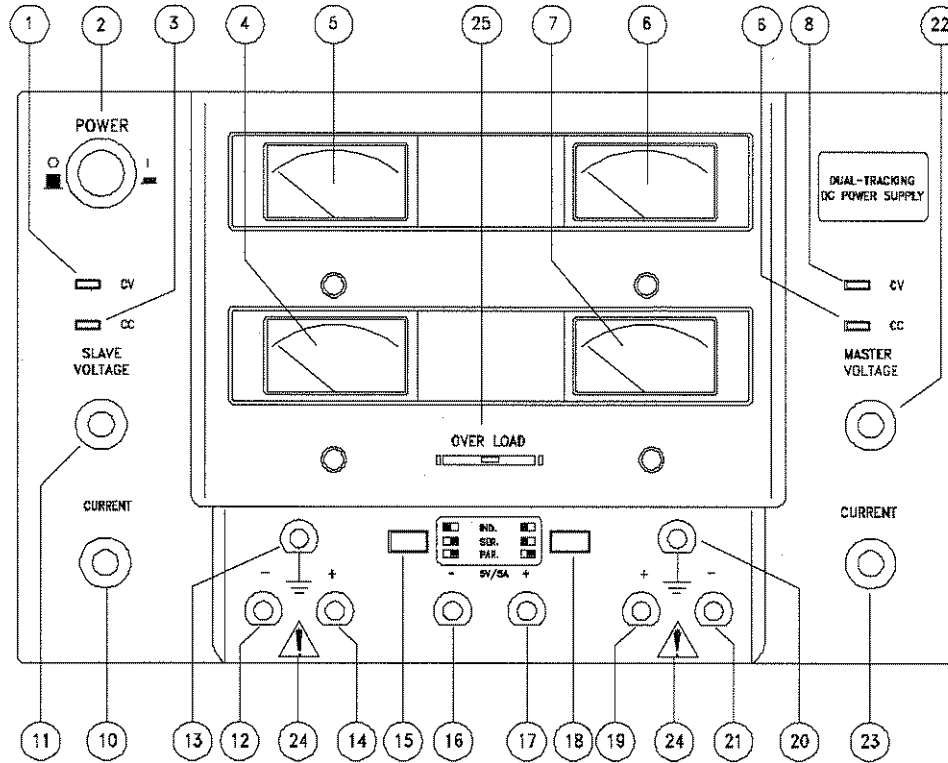

Front panel with analog meter for models 6302A, 6302AR, 6303A, 6303AR, 6306A, 6306AR, 6603A and 6603AR

Figure 1 Front Panels

- (1) C.V. Mode LED: Uses green LED to indicate constant voltage at slave power
- (2) Power Switch: Power ON/OFF switch (1=ON, 0 = OFF)
- (3) C.C. Mode LED: Uses red LED to indicate constant current at slave power
- (4) SLAVE Current Indicator
 - a) Analog: As indicated by the pointer on the 40x40mm (Class 2.5) meter
 - b) Digital: Displayed in full 3-digit red 0.52" LED

6000 Series

- (5) SLAVE Voltage Indicator
 - a) Analog: As indicated by the pointer in the 40 x 40 mm (Class 2.5) meter
 - b) Digital: Displayed in full 3-digit red 0.52" LED
- (6) MASTER Voltage Indicator
 - a) Analog: As indicated by the pointer on the 40 x 40 mm (Class 2.5) meter
 - b) Digital: Displayed in full 3-digit red 0.52" LED
- (7) MASTER Current Indicator
 - a) Analog: As indicated by the pointer on the 40 x 40 mm (Class 2.5) meter
 - b) Digital: Displayed in full 3-digit red 0.52" LED
- (8) C.V. Mode LED: Uses green LED to indicate constant voltage at master power
- (9) C.C. Mode LED: Uses red LED to indicate constant current at master power
- (10) SLAVE Current Adjustment Knob: For adjusting output current when slave is at constant current (C.C.) mode
- (11) Slave Voltage Adjustment Knob: For adjusting output voltage when slave is at constant voltage (C.V.) mode
- (12) Slave - Output Terminal: Slave negative output terminal (black)
- (13) Slave GND Terminal: Slave ground terminal (green)
- (14) Slave + Output Terminal: Slave positive output terminal (red)
- (15) and (18) TRACKING MODE Switches: The switch setting label is located between these two switches and you can set the power supply to operate in any of the following modes:
 - IND: Independent Mode
 - SER: Series Mode
 - PAR: Parallel Mode
- (16) 5V- Output Terminal : 5V negative output terminal (black)
- (17) 5V+ Output Terminal: 5V positive output terminal (red)
- (19) Master - Output Terminal: Master negative output terminal (black)
- (20) Master GND Terminal: Master ground terminal (green)
- (21) Master + Output Terminal: Master positive output terminal (red)
- (22) MASTER Voltage Adjustment Knob: For adjusting output voltage when master power is at constant voltage (C.V.) mode
- (23) MASTER Current Adjustment Knob: For adjusting output current when master power is at constant current (C.C.) mode
- (24) Warning Label: The bare parts of the output terminals and fittings are electrical sensing parts. Do not touch these parts during use.
- (25) OVERLOAD LED: 5V/5A overload indicator LED (red)

6000 Series

2.2 Rear Panel

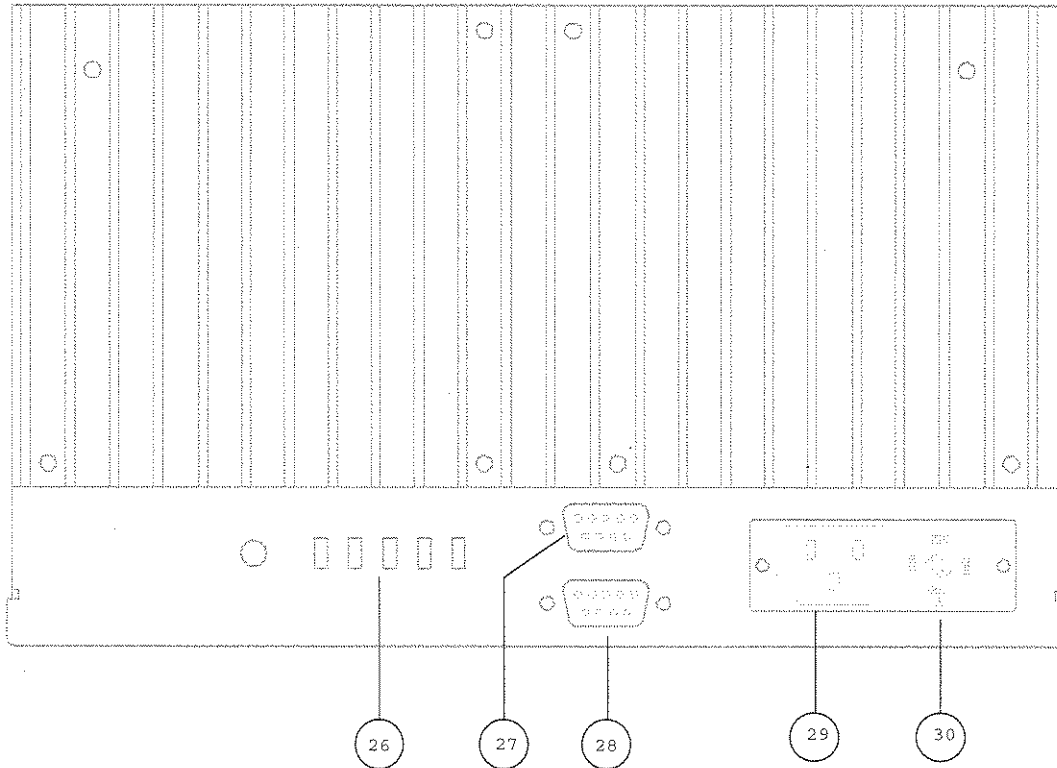

Figure 2 Rear Panel

- (26) Remote Control Function Switches: Only available on remote models. Refer to the Remote-Control Operation Manual for details.
- (27) D-Type 9-pin connector (RC1) for Remote Control
- (28) D-Type 9-pin connector (RC2) for Remote Control
- (29) Power Input Socket
- (30) Input Power Fuse Holder and Input Voltage Selector: Acceptable input voltage ratings are 100V, 120V, 220V and 240V. The selected input voltage is set to the position above the \triangle mark (the rear panel above shows that the input voltage is set to 100V).

3. Operation

3.1 Pre-installation

Before you turn on the power:

- Check that the input voltage from your power source conforms to the voltage rating selected. Refer to the Input Power Fuse Holder and Input Voltage Selector in section 2.2. The tolerance is $\pm 10\%$ of the indicated voltage at 50/60 Hz.
- Place this power supply in a well-ventilated area and do not to block the ventilation holes. Poor heat dissipation leads to overheating which may cause unstable operation and shorten the service life of this equipment.
- Be sure to use the correct fuse for your model. Refer to Table 1 for the type of fuse you should use for a given voltage.

3.2 Setting the Output Voltage and Output Current

To set the output voltage and current, follow these steps:

1. Check that the total load to be connected does not exceed the maximum output voltage and current of this power supply.
2. Open the circuit between the + and the - output terminals. Turn the voltage adjustment knob clockwise until you get the desired output voltage rating.
3. Turn the current adjustment knob counterclockwise until you get the minimum value.
4. Short the circuit between the + and the - output terminals. Note that the current rating of the shorting wire should be greater than or equal to the required current.
5. Turn the current adjustment knob clockwise until the current indicator on the front panel displays the required current rating.
6. Remove the shorting wire from the + and the - output terminals. The power supply returns to the constant voltage mode and is ready to use.

6000 Series

3.3 Constant Voltage/Constant Current Characteristics

This power supply can automatically operate between constant voltage and constant current by responding quickly to rapid load changes. The following figures shows the relative changes between the constant current and the constant voltage modes.

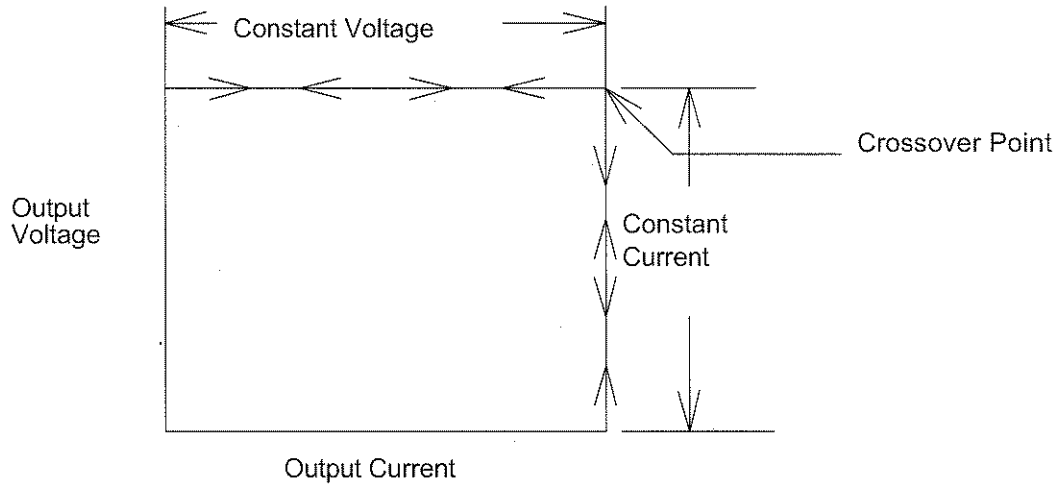

Figure 3 Constant Voltage/Constant Current

3.4 Operation Modes

3.4.1 Independent Mode

The master and the slave power can be used independently to generate voltage and current. To operate in the independent mode, follow these steps:

1. Set the TRACKING MODE switches on the front panel to IND.
2. Turn on the POWER switch.
3. Set the master output voltage and current as described in section 3.2.
4. Set the slave output voltage and current as described in section 3.2.

6000 Series

3.4.2 Serial Tracking Mode

Under this mode, the - Master Output Terminal is automatically shorted with the + Slave Output Terminal.

This serial output is generated from the + Master Output Terminal and the - Slave Output Terminal. The output voltage is twice the set master output voltage while the output current is the same as the master setting value.

To operate in the serial mode:

1. Set the TRACKING MODE switches on the front panel to SER.
2. Turn on the POWER switch.
3. Turn the SLAVE Current Adjustment Knob clockwise to maximum.
4. Set the master output voltage and current as described in section 3.2.

The following figures show two different serial operations:

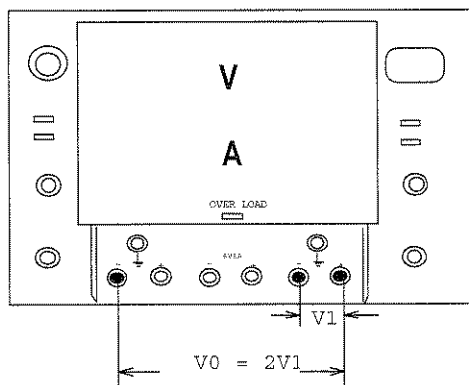

The output voltage is twice the set master output voltage. The output terminal is connected from the + Master Output Terminal to the - Slave Output Terminal.

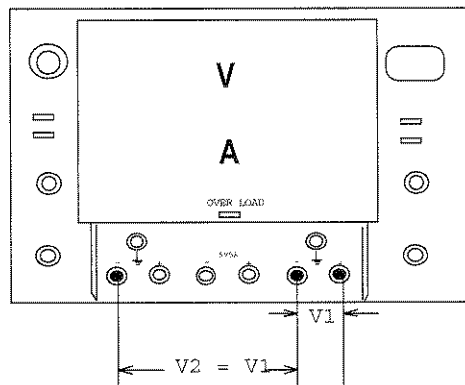

The output voltages for the master and the slave are the same. You can apply two independent loads or a load requiring both positive and negative voltages as long as the positive and negative voltages are the same.

Figure 4 Serial Connections

6000 Series

3.4.3 Parallel Tracking Mode

Under this mode, the - Master Output Terminal is shorted with the - Slave Output Terminal while the + Master Output Terminal is shorted with the + Slave Output Terminal automatically.

This parallel output is generated from the + Master Output Terminal and the -Master Output Terminal (or - Slave Output Terminal). The output current is twice the set master current while the output voltage is the same as the master setting value.

To operate in the parallel mode:

1. Set the TRACKING MODE switches on the front panel to PAR.
2. Turn on the POWER switch.
3. Turn the SLAVE Current and Voltage Adjustment Knobs clockwise to maximum.
4. Set the master output voltage and current as described in section 3.2.

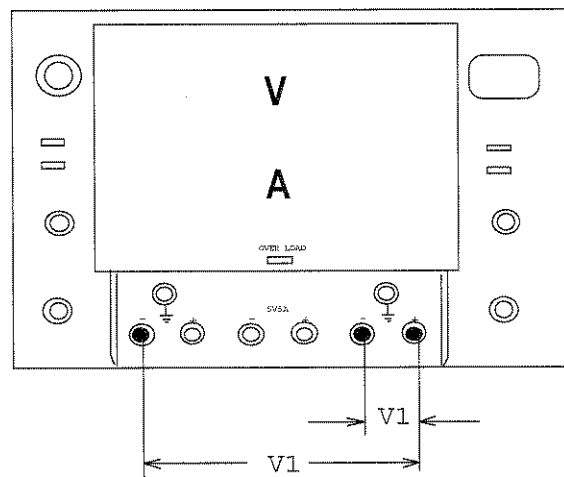

Figure 5 Parallel Connection

6000 Series

3.5 Fixed 5V/5A Output

This is the standard 5V/5A power output for use by TTL logic circuits. When the load exceeds 5 amperes, the red OVERLOAD LED lights up. The following figures show the parallel-output connection method and its characteristic curve.

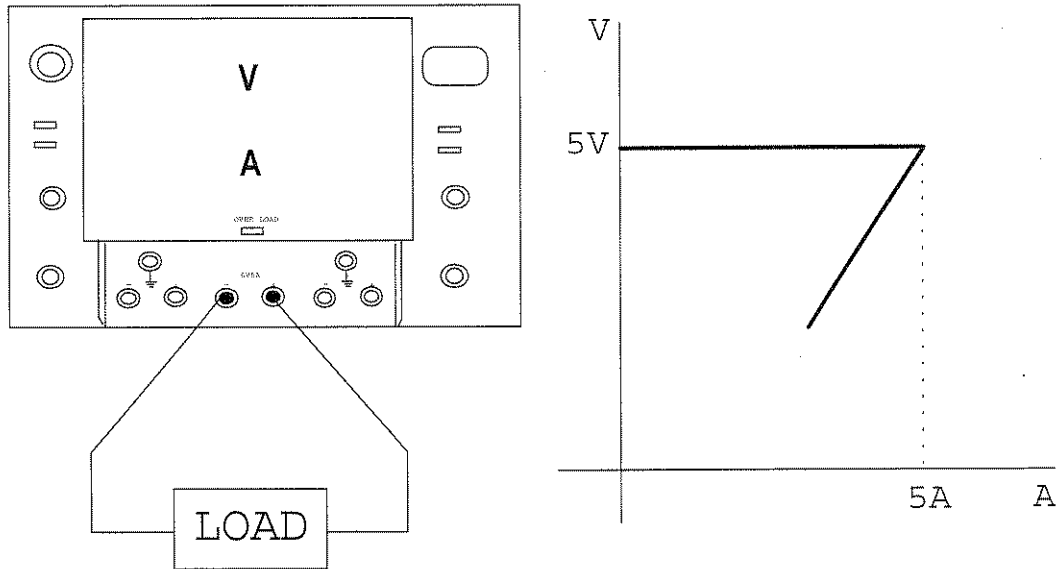

Figure 6 Fixed 5V/5A Output Connection

6000 Series

3.6 Serial Operation

Serial connection is used to connect two or more power supplies in series to obtain a higher voltage ratings (maximum 240V for this power supply).

Figure 7 shows the serial connection between two 6303D power supplies at series tracking. One unit is set at 60V/2A (MASTER setting is 30V/2A) while the other is at 40V/3A (MASTER setting is 20V/3A). Figure 8 shows the serial connection voltage/current output versus load changes.

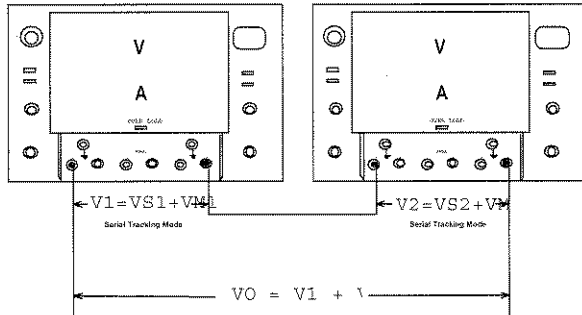

Figure 7 Serial Connection Diagram

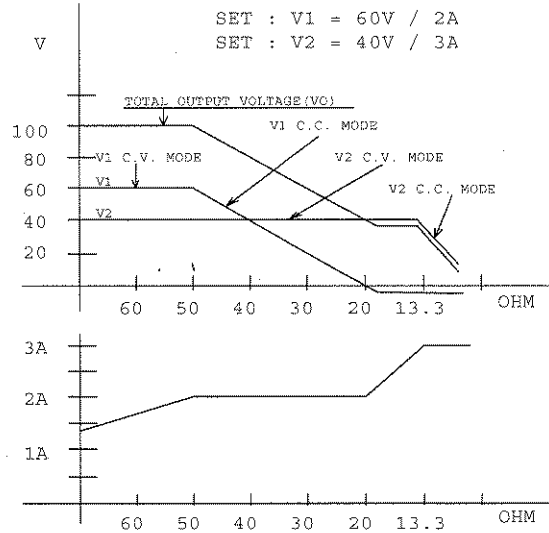

Figure 8 Serial Voltage/Current Output vs. Load Change

6000 Series

3.7 Parallel Operation

Parallel connection is used to connect two or more power supplies of the same model in parallel to obtain a higher current output (maximum 24A for this power supply).

Figure 9 shows the parallel connection between two 6303D power supplies at parallel tracking. One unit is set at 30V/5A (MASTER setting is 30V/2.5A) while the other is at 20V/6A (MASTER setting is 20V/3A). Figure 10 shows the parallel connection voltage/current output versus load changes.

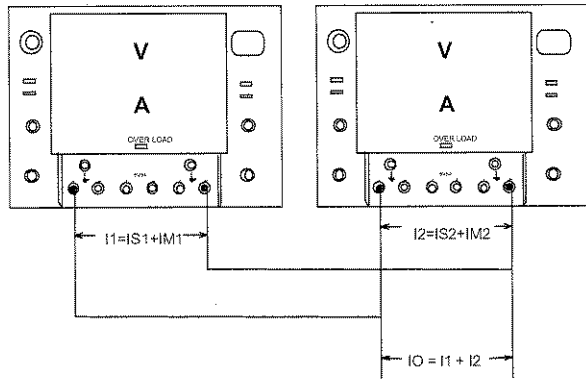

Figure 9 Parallel Connection Diagram

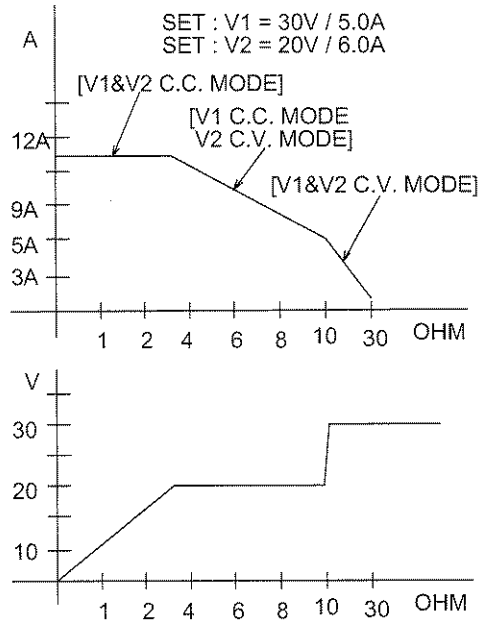

Figure 10 Parallel Voltage/Current Output vs. Load Change

NOTE: The difference between the voltage settings for two or more power supplies of the same model connected in parallel should not exceed 15V. The minimum voltage setting should not be less than 10V. If it is necessary to be lower than 10V, the voltage difference should be less than 2V. The closer to 0V, the smaller the difference required.

6000 Series

4. Maintenance

4.1 Changing the Fuse

The fuse is located inside the input power fuse holder (refer to Figure 2). You need to change the fuse when:

- the fuse is blown out
- you change the voltage rating

In any case, replace the fuse with one of the same rating. Refer to Table 1 for the type of fuse used for each model and voltage.

NOTE: Unplug the power cord before you change the fuse.

4.2 Changing the Voltage

To change the voltage, follow these steps:

1. Use a flathead screwdriver to detach the Input Power Fuse Holder and Input Voltage Selector unit (refer to Figure 2).
2. Turn the unit so that the desired input voltage is positioned above the \triangle mark.
4. Check that the fuse to conform to this new voltage rating. Refer to Table 1 below for the correct fuse rating.
5. Replace the Input Power Fuse Holder and Input Voltage Selector unit.

Table 1 Power Supply Weight, Dimensions and Fuse Specification

Model	Weight (Approx.)		Dimensions W x H x D (mm)		Fuse Time-Delay Type 6 x 30 mm			
	Net	Gross	Machine	Package	100V	120V	220V	240V
6302A/AR/D/DR	9.0 KG	10.5 KG	230x160x324	364x265x422	4A	4A	2A	2A
6303A/AR/D/DR	9.0 KG	10.5 KG	230x160x324	364x265x422	5A	5A	2.5A	2.5A
6306A/AR/D/DR	13 KG	14.4 KG	230x160x366	364x265x464	8A	8A	4A	4A
6603A/AR/D/DR	13 KG	14.4 KG	230x160x366	364x265x464	8A	8A	4A	4A

6000 Series

5. Specifications

Model	6302A	6303A	6306A	6603A	6302AR	6303AR	6306AR	6603AR
Specification	6302D	6303D	6306D	6603D	6302DR	6303DR	6306DR	6603DR
Output Voltage	0-30V x 2	0-30V x 2	0-30V x 2	0-60V x 2	0-30V x 2	0-30V x 2	0-30V x 2	0-60V x 2
Output Current	0-2A x 2	0-3A x 2	0-6A x 2	0-3A x 2	0-2A x 2	0-3A x 2	0-6A x 2	0-3A x 2
CONSTANT VOLTAGE CHARACTERISTICS								
Load Regulation	+ 0.01% + 2 mV				+ 0.01% + 2 mV			
Line Regulation	± 0.01% + 2 mV				± 0.01% + 2 mV			
Ripple & Noise (< 200W)	≤ 0.5mVrms				≤ 1mVrms			
Ripple & Noise (≥ 200W)	≤ 1mVrms				≤ 1mVrms			
CONSTANT CURRENT CHARACTERISTICS								
Load Regulation (<200W)	≤ 10mA				≤ 10mA			
Load Regulation (≥200W)	≤ 15mA				≤ 15mA			
Line Regulation	+ 0.01% + 2mA				+ 0.01% + 2mA			
Ripple & Noise (< 200W)	≤ 1mArms				≤ 1mArms			
Ripple & Noise (≥ 200W)	≤ 3mArms				≤ 3mArms			
DISPLAY ACCURACY								
Analog Display (A)	Full-scale 3%							
Digital Display (D)	≤ 0.1% + 2d							
PROGRAMMING SPEED								
Rise Time (No Load)	≤ 100mS							
(Load)	≤ 200mS (<6A), ≤ 500mS (<10A), ≤ 1S • ≥ 10A)							
Fall Time (No Load)	≤ 2.5S							
(Load)	≤ 250mS							
OUTPUT IMPEDANCE	≤ 2mΩ + 2 μH							
RECOVERY TIME	≤ 100 μS to within 0.1% of set voltage (50% to 100% load change)							
FUNCTIONS								
Series Connection	Different models can be connected in series (≤ 240V)							
Parallel Connection	Same models can be connected in parallel (≤ 24A)							
Master - Slave	N A				Yes			
REMOTE CONTROL								
Voltage Programmable By External DC Voltage By External Resistance	N A				0 to 10V, Control 0 to voltage setting 0 to 10KΩ, Control 0 to maximum voltage			
Current Programmable By External DC Voltage By External Resistance	N A				0 to 10V, Control 0 to current setting 0 to 10KΩ, Control 0 to maximum current			
TRACKING OPERATION								
Tracking Error	+ 0.2% + 10mV							
Series Regulation	+ 0.3% + 10mV							
5V FIXED OPERATION								
Load Regulation	≤ 10mV							
Line Regulation	≤ 5mV							
Ripple & Noise	≤ 2mVrms							
Voltage Accuracy	5V ± 0.25V							
Output Current	5A							

6000 Series

Specification	Model	6302A 6302D	6303A 6303D	6306A 6306D	6603A 6603D	6302AR 6302DR	6303AR 6303DR	6306AR 6306DR	6603AR 6603DR
Output Voltage		0-30V x 2	0-30V x 2	0-30V x 2	0-60V x 2	0-30V x 2	0-30V x 2	0-30V x 2	0-60V x 2
Output Current		0-2A x 2	0-3A x 2	0-6A x 2	0-3A x 2	0-2A x 2	0-3A x 2	0-6A x 2	0-3A x 2
VOLTAGE/CURRENT READBACK AVAILABLE									
Voltage Readback		NA			0 to 10V for full-scale voltage in Master				
Current Readback		NA			0 to 0.3V for full-scale current in Master				
OPERATION MODE									
Independent		Two independent outputs and 5V fixed output Output from 0 to rating voltage and 0 to rating ampere							
Serial		Output from 0 to + rating voltage at rating ampere Output from 0 to double rating voltage at rating ampere							
Parallel		Output from 0 to double rating current at voltage rating							
POWER SOURCE		ACV 100/120/220/240 \pm 10%, 50/60 Hz							
ACCESSORIES		ACS-002 X 2				ACS-002 X 2, 9-pin D-type connector x 2			
DIMENSIONS W X H X D (mm)		230 X 160 X 324		230 X 160 X 366		230 X 160 X 324		230 X 160 X 366	